

COMPAQ
COMPAQ IPAQ POCKET PC
H3700 SERIES
GETTING STARTED GUIDE

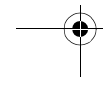
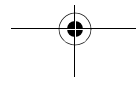

NOTICE

The information in this document is subject to change without notice.

COMPAQ COMPUTER CORPORATION SHALL NOT BE LIABLE FOR TECHNICAL OR EDITORIAL ERRORS OR OMISSIONS CONTAINED HEREIN; NOR FOR INCIDENTAL OR CONSEQUENTIAL DAMAGES RESULTING FROM THE FURNISHING, PERFORMANCE, OR USE OF THIS MATERIAL.

This document contains information protected by copyright. No part of this document may be photocopied or reproduced in any form without prior written consent from Compaq Computer Corporation.

© 2001 Compaq Computer Corporation.

Compaq, the Compaq logo, and iPAQ are trademarks of Compaq Information Technologies Group, L.P. in the US and other countries. Microsoft, MS, ActiveSync, Windows, Windows NT, and the Windows logo are trademarks of Microsoft Corporation. Intel is a trademark of Intel Corporation. All other product names mentioned herein may be trademarks of their respective companies. Compaq shall not be liable for technical or editorial errors or omissions contained herein. The information in this document is provided "as is" without warranty of any kind and is

subject to change without notice.

The warranties for Compaq products are set forth in the express limited warranty statement accompanying such products. Nothing herein should be construed as constituting an additional warranty.

Compaq iPAQ Pocket PC H3700 Series Getting Started Guide
First Edition September 2001
Part Number 254573-001

Contents

Getting Acquainted	1	Using Software	42
What Is in the Box?	2	Use Microsoft Reader	42
Register	5	Regulatory Notices	44
Set Up Your Compaq iPAQ Pocket PC	5	Federal Communications Commission Notice	44
Charge Your Compaq iPAQ Pocket PC	7	Canadian Notice	45
Navigate through the Interface	12	Avis Canadien	45
Enter Information	20	European Union Notice	45
Communicating	30	Battery Warning	46
Work with Contacts.	30	Airline Travel Notice	46
Scheduling	33	Power Cords	46
Use the Today Screen	33	Hardware Specifications	48
Use the Calendar	37	System Specifications	48
Use Tasks	39	Physical Specifications	49
		Operating Environment	50



Routine Care and Battery Guidelines . . .51

Routine Care 51

Battery Guidelines 51

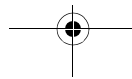
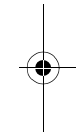
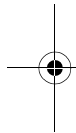

Getting Acquainted

To use your Compaq *iPAQ™* Pocket PC H3700 Series most effectively, start by learning how to

- register your Compaq iPAQ Pocket PC
- set up your Compaq iPAQ Pocket PC
- set up synchronization
- navigate through the interface
- enter information

Because your Compaq iPAQ Pocket PC uses some power to

maintain files in RAM and the clock, you need to recharge the battery regularly. Keep the Compaq iPAQ Pocket PC connected to the cradle or the AC adapter while you are at your desk. The best policy is to keep the Compaq iPAQ Pocket PC connected to your computer when working at your desk and carry your AC adapter with you when traveling.

Your Compaq iPAQ Pocket PC is shipped with a charge on the battery. You may want to ensure that it is fully charged before synchronizing.

CAUTION: Because most of the applications and data you install on your Compaq iPAQ Pocket PC are held in memory, you will need to reinstall them if the battery completely discharges.

What Is in the Box?

What Is in the Box?
Your Compaq iPAQ Pocket PC ships with

- the Getting Started Guide
- Compaq iPAQ Pocket PC Companion CD-ROM
 - Microsoft® ActiveSync 3.5 software on the Companion CD-ROM
 - Add-on software and applications for some models

- detailed eBook guide, which you can copy to your Compaq iPAQ Pocket PC
- comprehensive printable reference guide
- a cradle
- an AC adapter

If items are missing, contact Customer Support at the numbers provided in the *Worldwide Telephone Numbers* booklet.



Front Panel

- ❶ Stylus: tap, draw, or write
- ❷ Power Button
- ❸ Power Indicator: alarm charge light
- ❹ Light sensor: adjusts backlight
- ❺ Speaker
- ❻ iPAQ Navigation/Action Button 5: scroll through a list, open a selected item
- ❼ Programmable Application Buttons 1-4 (left to right): navigate to applications, default: button 1 is Calendar, button 2 is Contacts, button 3 is Inbox, button 4 is iPAQ Task
- ❽ Record Button
- ❾ Microphone
- ❿ Stereo Headphone Jack
- ⓫ Infrared Port: exchange information with other Windows-powered devices
- ⓬ Stylus Release Button: eject the stylus

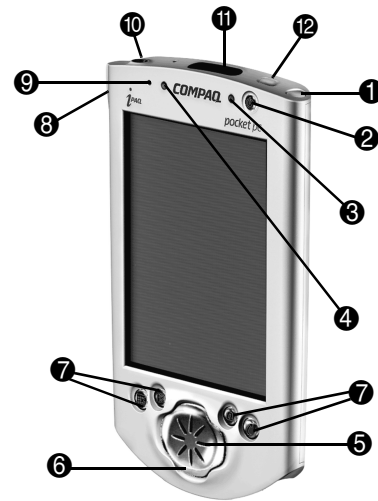

What is in the Box?

Top Panel

- ❶ Stereo Headphone Jack
- ❷ Infrared Port: exchange information with other Windows-powered devices
- ❸ Stylus Release Button: eject the stylus
- ❹ Stylus: tap, draw, or write

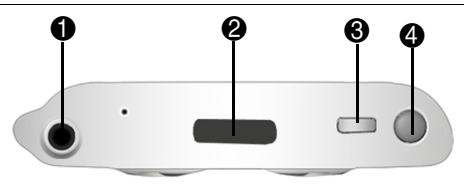

Bottom Panel

- ❶ Communications Port: connect to cradle, USB, or serial cable.
- ❷ Reset Button: reset with stylus
- ❸ On/Off Switch: clear all information
- ❹ DC Jack: connect to external power
- ❺ iPAQ Expansion Pack Connector: connect to an optional Expansion Pack

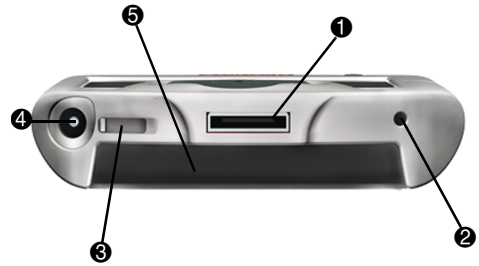

Register

You can receive the latest information on your Compaq iPAQ Pocket PC, as well as special offers on Compaq iPAQ Pocket PC accessories and software, by registering with Compaq online at <http://www.compaq.com/register> or by completing and mailing the *Register Now** card included in the shipping box.

*Not available in all countries

Set Up Your Compaq iPAQ Pocket PC

To set up your Compaq iPAQ Pocket PC

- 1 Turn on the battery
- 2 Personalize your Compaq iPAQ Pocket PC (see page 6)

- 3 Set up synchronization (see page 6)

Turn on the battery

Before you set up your Compaq iPAQ Pocket PC, turn on the battery.

CAUTION: For synchronization to work properly, install Microsoft ActiveSync 3.5 before you first connect your Compaq iPAQ Pocket PC to your computer.

Your Compaq iPAQ Pocket PC is shipped with a charge on the battery. You may want to ensure that it is fully charged before synchronizing.

- 1 With the stylus, open the On/Off door at the bottom of your Compaq iPAQ Pocket PC
- 2 Move the On/Off switch to the On position at the left
- 3 Close the On/Off door

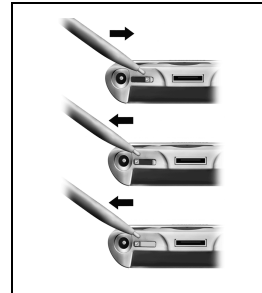

Register

Personalize your Compaq iPAQ Pocket PC

When you turn on the screen of your Compaq iPAQ Pocket PC for the first time, you are guided through Welcome screens. Follow the instructions to

- realign your screen
- learn about the stylus
- learn about the pop-up menus
- select your time zone

- 1 Press the **Power button to turn on the screen if necessary**
- 2 Follow the instructions on the **Welcome screens**



Set up Synchronization

Synchronizing allows you to share information between your Compaq iPAQ Pocket PC and your computer or your server. Please note that you should set up synchronization when you first connect your Compaq iPAQ Pocket PC to your computer.

CAUTION: For synchronization to work properly, install Microsoft ActiveSync 3.5 before your Compaq iPAQ Pocket PC is connected to your computer for the first time.

During installation,

- create partnerships, which allow you to synchronize information with multiple computers
- connect the cradle to your computer
- select the information to synchronize with your Compaq iPAQ Pocket PC, for example, Contacts, Calendar, Inbox, Tasks, Favorites, Files, Notes, and AvantGo

1 Insert the Compaq iPAQ Pocket PC Companion CD-ROM

2 Follow the instructions on the screen for installing Microsoft ActiveSync 3.5

For more help, click on the Microsoft ActiveSync 3.5 Help button during installation

3 Locate the cradle

4 Insert the AC adapter plug into the DC jack on the back of the cradle

5 Attach either the USB or serial cable to your computer

6 Slide the bottom of your Compaq iPAQ Pocket PC into the cradle and push firmly

Microsoft ActiveSync 3.5 installation will resume

7 Select the information to synchronize with your Compaq iPAQ Pocket PC

The information you select will automatically synchronize when your installation is complete

8 Leave your Compaq iPAQ Pocket PC in the cradle until the light stops blinking and the battery is charged

The setup of your Compaq iPAQ Pocket PC is now complete

9 Go to the Companion CD-ROM to install extra soft-

ware to enhance your Compaq iPAQ Pocket PC

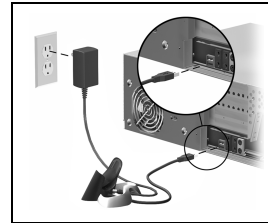

Charge Your Compaq iPAQ Pocket PC

Charge your Compaq iPAQ Pocket PC on a regular basis with the AC adapter or the cradle.

Charge with the cradle

Charge your Compaq iPAQ Pocket PC with the cradle. Use the cradle to

Charge Your Compaq iPAQ Pocket PC

- synchronize with your computer
- recharge the battery of an optional expansion pack, if you have purchased one (for example, recharge the battery of the Dual-slot PC Card Expansion Pack)

Slide the bottom of your Compaq iPAQ Pocket PC into the cradle and push firmly

The charge light blinks when your Compaq iPAQ Pocket PC is recharging the battery

The charge light is solid (non-blinking) when the battery is fully charged

Microsoft ActiveSync 3.5 opens on your computer and recognizes your Compaq iPAQ Pocket PC

Charge with the AC adapter

Because your Compaq iPAQ Pocket PC uses some power to maintain RAM and the clock, you need to recharge the battery regularly. Keep the Compaq iPAQ Pocket PC connected to the cradle or the AC adapter while you are at your desk. The best policy is to keep the Compaq iPAQ Pocket PC connected to your computer when working at your desk and carry your AC adapter with you when traveling.

CAUTION: Because most of the applications and data you install on your Compaq iPAQ Pocket PC are held in memory, you will need to reinstall them if

the battery completely discharges.

Use the AC adapter to also charge your optional expansion pack, if you have purchased one. For more information about expansion packs, see Expanding Functionality with Expansion Packs in the eBook guide or the printable reference guide available on the CD-ROM.

The standard adapter works in any household outlet. You can also purchase one that works in your car's cigarette lighter or a 12-volt power outlet.

CAUTION: Use only Compaq recommended AC adapters.

- 1 Locate the AC adapter
- 2 Plug the AC adapter into an outlet
- 3 Insert the DC adapter plug into the bottom of your Compaq iPAQ Pocket PC

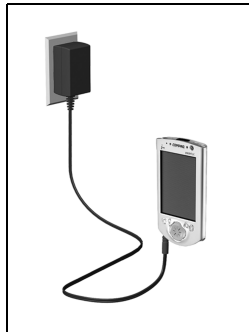

Change the backlight settings

- 1 From the Start menu, tap Settings

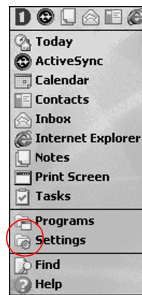

- 2 Tap System

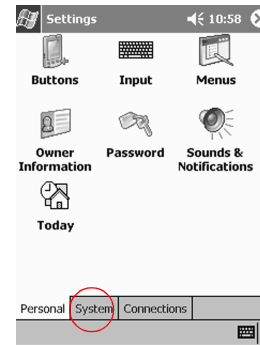

- 3 Tap Backlight

Charge Your Compaq iPAQ Pocket PC

4 Select the backlight settings

On the Battery Power tab, select when to use the backlight on battery power

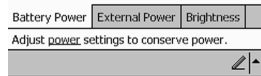

On the External Power tab, select when to use the backlight on external power

On the Brightness tab, select the level of brightness for the backlight

Hint: Slide the bar to the lowest level to conserve the most power

Tips

I cannot see anything on the screen

1 Make sure the screen is on
Press the power button

2 Make sure the Compaq iPAQ Pocket PC is connected to the AC adapter and the cradle

Plug the AC adapter into an outlet

Insert the DC adapter plug into the cradle

I cannot keep my battery charged

Always keep the Compaq iPAQ Pocket PC connected to a cradle or AC adapter when you are not using it

In the backlight settings slide the bar to the lowest level to conserve the most power

I do not see the charge light blinking when my Compaq iPAQ Pocket PC is connected to the cradle

1 Make sure the cradle is plugged into an outlet

2 Make sure the bottom of your Compaq iPAQ Pocket PC is pushed firmly into the cradle

3 Determine if the unit is fully charged

The charge light does not blink when the unit is fully charged.

- From the Start menu, tap Settings
- Tap System
- Tap Power

The backlight keeps turning off

The backlight turns off to conserve power

On the Battery Power tab, change the time the backlight stays on and choose to have the backlight turn on when you touch the screen or push a button

My Compaq iPAQ Pocket PC is not responding or an application hangs

Perform a soft reset of your Compaq iPAQ Pocket PC

- 1 Insert the stylus into the unit reset switch at the bottom of your Compaq iPAQ Pocket PC**
- 2 Press the switch for 1 second**

I forgot my password

Perform a hard reset of your Compaq iPAQ Pocket PC

CAUTION: Because most of the applications and data you install on your Compaq iPAQ Pocket PC are held in memory, you will need to reinstall them if you perform a hard reset.

- 1 With the stylus, slide open the On/Off door at the bottom of your Compaq iPAQ Pocket PC**
- 2 Slide the On/Off switch to the Off position at the right**
- 3 Wait about 1 minute**
- 4 Slide the On/Off switch to the On position at the left**
- 5 Close the On/Off door**
- 6 Follow the instructions on the screen**

Charge Your Compaq iPAQ Pocket PC

Navigate through the Interface

Navigate through the Compaq iPAQ Pocket PC interface in three ways:

- tap
- tap and hold
- press application buttons

Tap the screen with the pointed tip of your stylus to open applications and make selections. For example, tap the Start menu to see a list of applications available.

Tap and hold an area on the screen to see a pop-up menu.

Press an application button on the front panel to quickly turn on the screen and open your Calendar or your Contacts or make a recording.

Realign the screen

When you turn on the screen of your Compaq iPAQ Pocket PC for the first time, you are guided through the alignment process.

Realign your screen if

- the Compaq iPAQ Pocket PC does not respond accurately to your taps
- you perform a hard reset of your Compaq iPAQ Pocket PC

1 From the Start menu, tap Settings

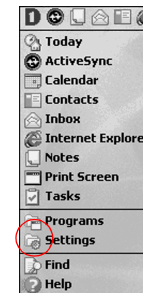

2 Tap System

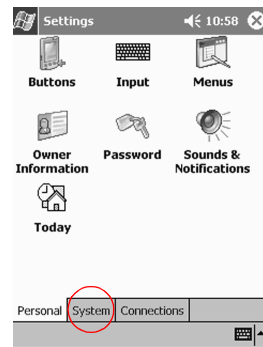

3 Tap the Screen icon

4 Tap the Align Screen button to begin the realignment process

5 Tap the cross-hair object at each location to realign the screen

Be precise when you tap the cross-hair object

6 Tap OK

Open applications

Most applications on your Compaq iPAQ Pocket PC are only two taps away from any screen. Open any application on your Compaq iPAQ Pocket PC from the Start menu.

Hint: Open any application by assigning it to an application button

1 Tap Start or the Microsoft logo at the upper left of the

screen on the menu bar to open the Start menu

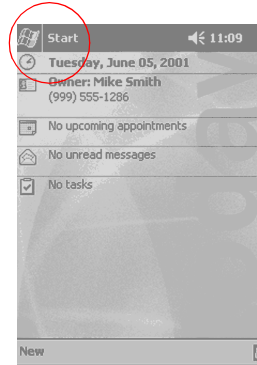

Otherwise, tap the application title on the menu bar to open the Start menu

Navigate through the Interface

- 2 Tap Programs to see the applications on your Compaq iPAQ Pocket PC

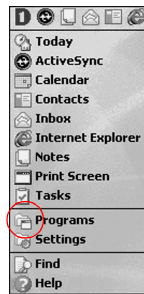

- 3 Tap the application title or icon to open it

Minimize applications

From the application you would like to minimize, tap the x

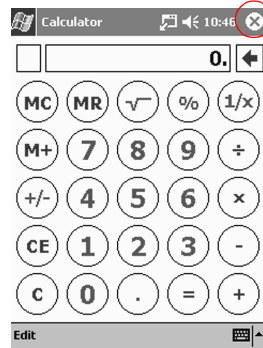

Close applications

Applications should close automatically as you open new applications. However, if your Compaq

iPAQ Pocket PC is running slowly, manually close applications.

- 1 From the Start menu, tap Settings

- 2 Tap System

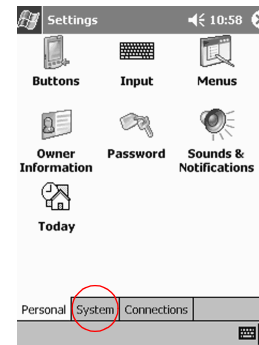

- 3 Tap Memory

4 Tap Running Programs

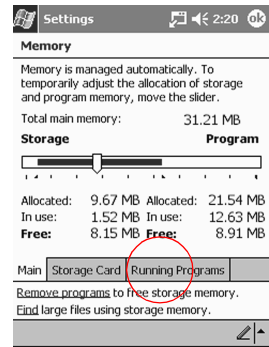

5 Tap Stop All to close all applications

Otherwise, select an application and tap Stop

Set the time for home

When you turn on the screen of your Compaq iPAQ Pocket PC for the first time, you are guided through setting the time. Set the time again if

- the battery completely discharges
- you perform a hard reset of your Compaq iPAQ Pocket PC

Hint: From the Today screen, tap the clock icon to set the time.

1 From the Start menu, tap Settings

2 Tap System

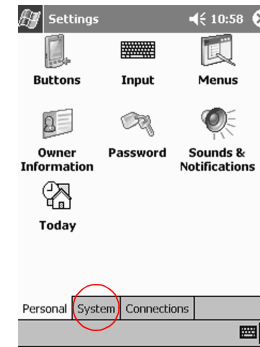

3 Tap Clock

4 Tap Home

Navigate through the Interface

- 5 Tap the time-zone down arrow to select your location and time zone**

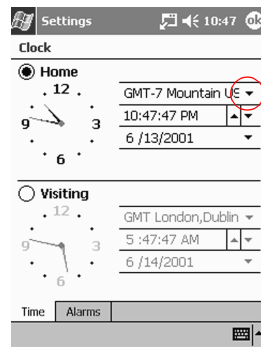

- 6 Tap the hour, minutes, or seconds to select the time you want to adjust**

- 7 Tap the up or down arrow to adjust the time**

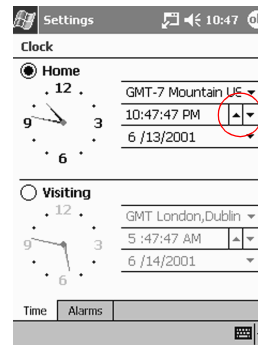

- Otherwise, move the hands of the clock with the stylus to adjust the time
- 8 Tap AM or PM to change the time to AM or PM**

- 9 Tap OK**

- 10 Tap Yes to save your clock settings**

Set the time for a location you are visiting

Set the time for a location you are visiting.

Hint: From the Today screen, tap the clock icon to set the time.

- 1 From the Start menu, tap Settings**

2 Tap System

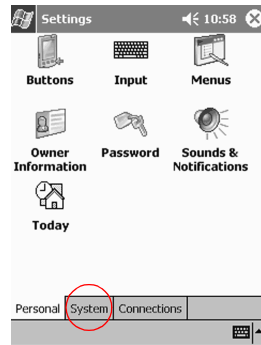

3 Tap Clock

4 Tap Visiting

5 Tap the time-zone down arrow to select the location and time zone

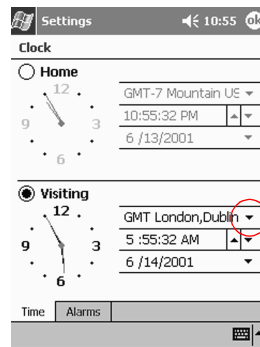

6 Tap the hour, minutes, or seconds to select the time you want to adjust

7 Tap the up or down arrow to adjust the time

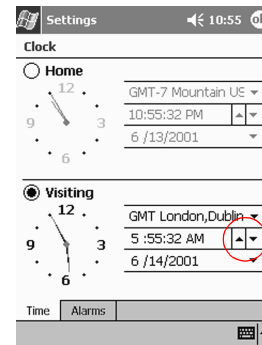

Otherwise, move the hands of the clock with the stylus to adjust the time

8 Tap AM or PM to change the time to AM or PM

Navigate through the Interface

9 Tap OK

10 Tap Yes to save your clock settings

Set the date

When you turn on the screen of your Compaq iPAQ Pocket PC for the first time, set the date. Set the date again if

- the battery discharges completely
- you perform a hard reset of your Compaq iPAQ Pocket PC

Hint: From the Today screen, tap the clock icon to set the date.

1 From the Start menu, tap Settings

2 Tap System

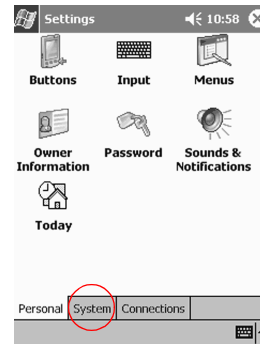

3 Tap Clock

4 Tap the date down arrow to see a calendar

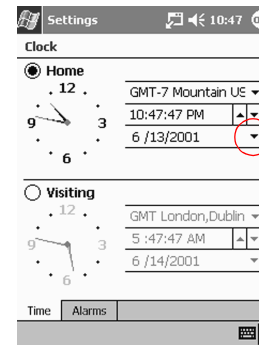

- 5 Tap the left or right arrow to move backward or forward through the calendar

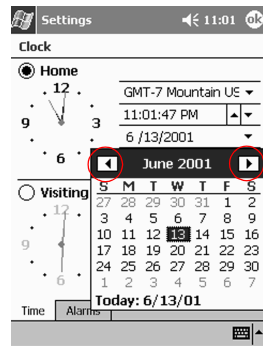

- 6 Tap a day to select the date
- 7 Tap OK
- 8 Tap Yes to save your date settings

Customize the application buttons

By pressing an application button on the front panel, quickly open your Calendar or your Contacts or make a recording.

Customize the front panel buttons to open other applications.

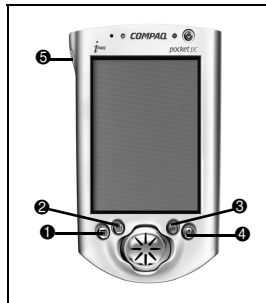

- 1 From the Start menu, tap Settings
- 2 Tap Buttons
- 3 Tap the button you want to change

4 Tap the button-assignment down arrow to see a list of applications

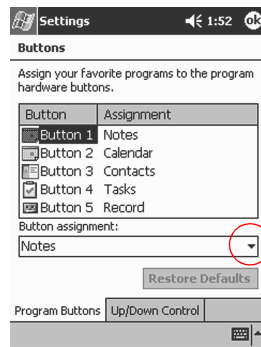

- 5 Tap an application**
- 6 Tap OK to assign the application to the button**

Tips

I want to restore the default assignments to the application buttons

- 1 From the Start menu, tap Settings
- 2 Tap Buttons
- 3 Tap Restore Defaults
- 4 Tap OK

Enter Information

Enter letters, symbols, and numbers on the Compaq iPAQ Pocket PC screen by

- tapping the Keyboard
- writing with the stylus and using the Letter Recognizer to create text

- writing with the stylus and using the Transcriber to create text
- writing with the stylus and using the Block Recognizer to create text
- drawing and writing with the stylus

Tap the Keyboard, write with the stylus and the Letter Recognizer, write with the stylus and the Transcriber, and write with the stylus and the Block Recognizer in any application. Use the stylus and draw and write on the screen in the Notes application and from any Notes tab in the Calendar, Contacts, and Tasks applications.

Please note that as you type or write, the Compaq iPAQ Pocket PC suggests words for you in a box above the Keyboard, Letter Recog-

nizer, or Block Recognizer but not in the Transcriber. Change when the suggestions occur (for example, decide how many letters you must enter before the Letter Recognizer will make suggestions) and how many words are suggested.

Change word suggestion options

Change

- if words are suggested
- the number of letters you must enter before a word is suggested
- the number of words that are suggested per entry

1 From the Start menu, tap Settings

2 Tap Input

3 Tap Word Completion

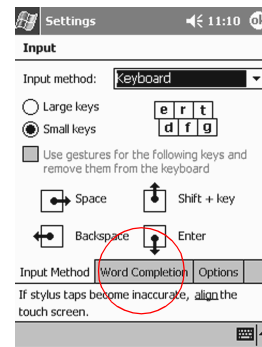

4 Tap the down arrow to change the number of letters needed for suggestion

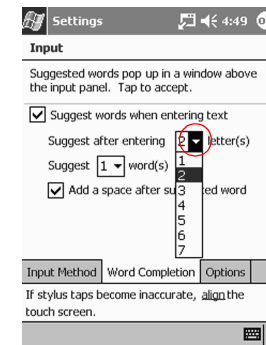

5 Tap the down arrow to change the number of words to suggest

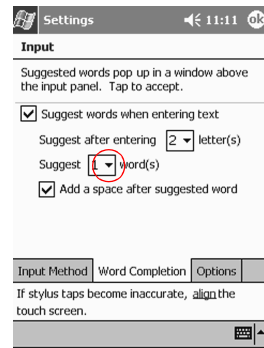

6 Tap to de-select Suggest Words if you do not want any suggestions

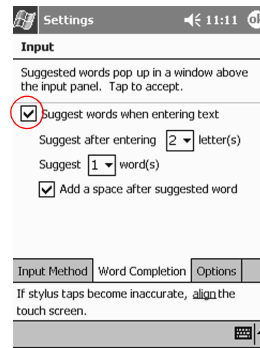

7 Tap OK to save your changes

Type with the on-screen Keyboard

Enter typed text directly on the screen by tapping letters, numbers, and symbols on the Keyboard.

Hint: To see the symbols, tap the 123 or Shift key.

- 1 From any application, tap the up arrow next to the Input Panel button



- 2 Tap Keyboard to display a keyboard on the screen
- 3 Tap a letter, symbol, or number to enter information

Write with the stylus and the Letter Recognizer

Write letters, numbers, and symbols on the screen using the stylus and the Letter Recognizer. Create words and sentences by writing in upper case (ABC), lower case (abc), and symbols (123) in specific areas.

- 1 From any application, tap the up arrow next to the Input Panel button
- 2 Tap Letter Recognizer to see a writing area
- 3 Write a letter or symbol between the dashed line and

baseline for the Letter Recognizer to work effectively

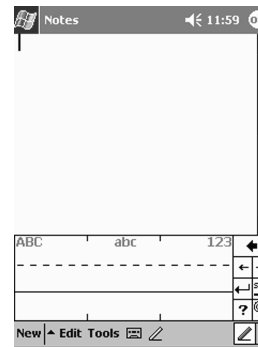

Write a letter between the hatchmarks labeled ABC to type text in upper case

Write a letter between the hatchmarks labeled abc to type text in lower case

Write a number or symbol between the hatchmarks labeled 123 to type symbols

4 What you write on the screen will be converted to text

Write with the stylus and the Transcriber

Write words, letters, numbers, and symbols anywhere on the screen using the stylus and the Transcriber.

- 1 From any application, tap the up arrow next to the Input Panel button
- 2 Tap Transcriber

- 3 Write anywhere on the screen
- 4 What you write on the screen will be converted to text

Write with the stylus and Block Recognizer

Write letters, numbers, and symbols using the stylus and the Block Recognizer. Create words and sentences by writing letters and numbers in specific areas.

- 1 From any application, tap the up arrow next to the Input Panel button
- 2 Tap Block Recognizer to see a writing area
- 3 Write a word, letter, or symbol between the hatchmarks

Write a letter between the hatchmarks labeled abc to type text

Write a number or symbol between the hatchmarks labeled 123 to type a number or symbol

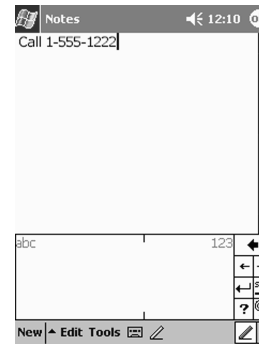

4 What you write on the screen will be converted to text

Draw and write on the screen

Use the stylus as a pen to draw and write on the screen in the Notes application or from the Notes tab in

- Calendar
- Contacts
- Tasks

1 From the Start menu, tap Notes

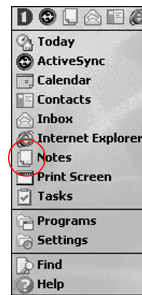

2 Tap New

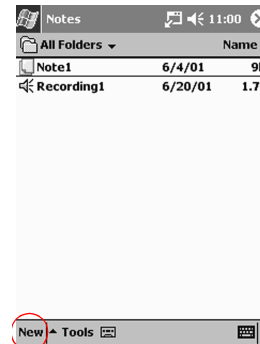

Otherwise, tap the Notes tab in Calendar, Contacts, or Tasks and tap the Pen icon

3 Draw and write on the screen

4 Tap the Pen icon to de-select it

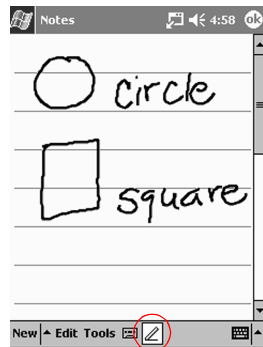

- Calendar
- Contacts
- Tasks

1 From the Start menu, tap Notes

Otherwise, tap the Notes tab in Calendar, Contacts, or Tasks

2 Tap a note to open it

3 Highlight the word(s) you want to convert to text

5 Tap OK

Convert writing to text

Convert your writing to text when you write with the pen in the Notes application or from the Notes tab in

4 Tap Tools to see a pop-up menu



5 Tap Recognize to convert writing to text

If you select more than one word to convert to text and one is not recognized, all the other

words will be converted to text.
The unrecognized word will
remain written.

6 Tap OK

Tips

*I want to address an e-mail
message, but I cannot find the
@ symbol*

**1 Tap the up arrow next to the
Input Panel button**

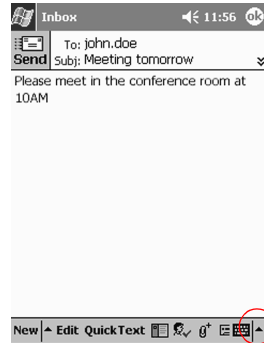

**2 Tap Keyboard to display a
keyboard on the screen**

3 Tap the Shift key



4 Tap the @ key where appropriate in an e-mail address

I cannot get the Letter Recognizer to type the correct letter

- 1 Make sure you are writing in the appropriate area (for example, ABC, abc, or 123)
- 2 Write letters without picking up the stylus from the screen

Whenever possible, use one continuous movement to write letters

I did not get the correct word conversion from writing to text. Are there any other possibilities?

- 1 Highlight the word(s) you wrote

2 Tap Tools

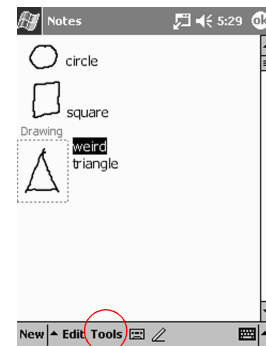

- 3 Tap Alternates to see a list of words

4 Tap an alternate

You may want to write the word again if the alternates are not correct

5 Tap OK

The application does not recognize my writing

- 1 Write your letters close together
- 2 Leave plenty of space between words
- 3 Zoom in to improve character recognition
- 4 Use the lined page
- 5 Write legibly and try to stay between the lines

I want to change the words I typed on the Keyboard or wrote in the Letter Recognizer

- 1 Highlight the word(s) you typed or wrote



2 Type or write over the word(s)

Otherwise, tap and hold the highlighted text to see a pop-up menu with cut, copy, paste, and clear options

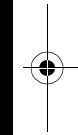
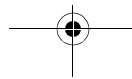
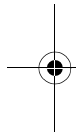

Your Compaq iPAQ Pocket PC H3700 Series lets you communicate in many ways, such as working with contacts.

To take full advantage of the many Compaq iPAQ Pocket PC functions, ensure that you have installed Microsoft ActiveSync 3.5 on your computer before connecting your Compaq iPAQ Pocket PC.

Work with Contacts

Enter and view information about friends, family members, or business associates in the Contacts application.

Work with your contact information and do any of the following:

- create a contact
- view and edit a contact

Hint: Press the Contact application button to navigate quickly to Contacts.

Create a contact

Hint: Create a contact from the Today screen.

Communicating

- 1 From the Start menu, tap **Contacts**

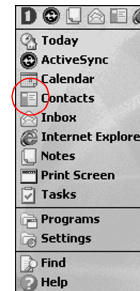

2 Tap New to create a new contact



3 Tap any item and enter information

Scroll down to see more fields

4 Tap the down arrow next to any item and enter additional details about the item

For example, tap the Name down arrow to enter the contact's title, first, middle, and last name, and suffix

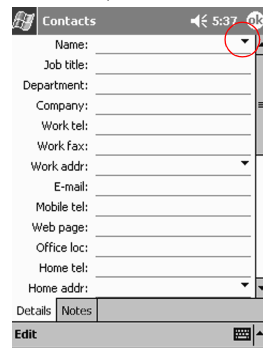

- Tap anywhere outside the box to stop entering details
- 5 Tap OK to save the contact information and return to the list of contacts**

View and edit a contact

- 1 From the Start menu, tap Contacts to display a list of your contacts from the last category selected**

- 2 Tap the down arrow next to the category name to see the list of categories**

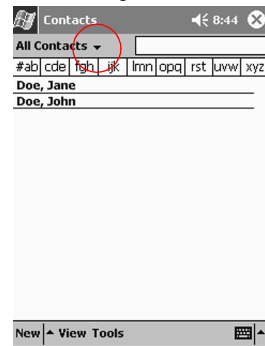

- 3 Tap a category name to see a list of contacts placed in that category**
- 4 Tap a contact's name**

- 5 Tap Edit to see the contact information**

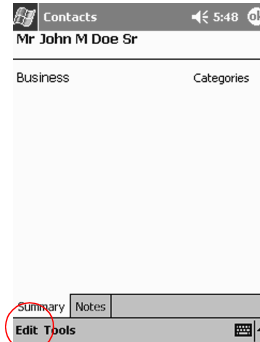

- 6 Edit the contact information and tap OK to save the contact information and return to the list of contacts**

Your Compaq iPAQ Pocket PC H3700 Series helps you keep track of your schedule in many ways:

- see information at a glance on the Today screen
- set appointments and create reminders with the Calendar
- create a task list

Use the Today Screen

You see the Today screen when you first turn on the screen of your Compaq iPAQ Pocket PC. Use the Today screen to view your

- owner information
- upcoming appointments

- unread and unsent messages
- tasks that need to be completed

From the Today screen, open the New menu to create new

- appointments
- contacts
- e-mail
- Excel workbooks
- notes
- tasks
- Word documents

Create new information from the Today screen

From the Today screen, create new information, including

- appointments
- contacts
- e-mail
- Excel workbook information
- notes
- tasks
- Word documents

For more information on creating these items, see the appropriate instructions for each task in this guide. For example, to create a new appointment, see Schedule an appointment and set a reminder.

Scheduling

1 From the Start menu, tap Today

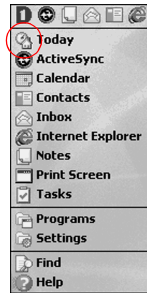

2 Tap New to open the New menu

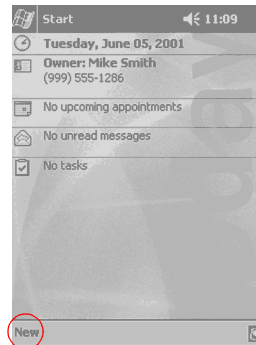

3 Tap to create a new item
Change information from the Today screen

From the Today screen, change information, including

- owner information
- upcoming appointments
- unread and unsent messages
- tasks that need to be completed

For more information on changing these items, see the appropriate instructions for each task in this guide. For example, to create a new appointment, see Schedule an appointment and set a reminder.

- 1 From the Start menu, tap Today**
- 2 Tap the information you want to change**

Use the Today Screen

3 Enter or change the information

Settings

Owner Information

Name: Mike Smith

Company: AB Co.

Address:

Telephone: (999) 555-1286

E mail:

Show information when device is turned on

Identification Notes

4 Tap OK to save changes and return to the Today screen

Otherwise, tap OK and from the Start menu, tap Today to return to the Today screen

Customize the appearance of the Today screen

From the Today Settings screen,

- add a picture as the background
- select the information you see
- set the order of the information
- decide when to see the Today screen

1 From the Start menu, tap Settings

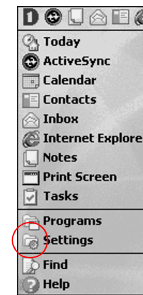

2 Tap Today

3 Add a picture

Tap the checkbox to use your picture as the background

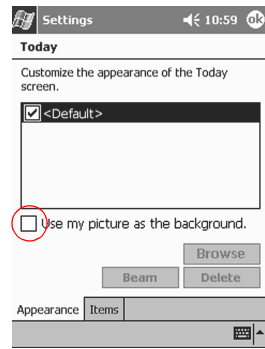

Tap Browse to select a picture from File Explorer

4 Tap Items to select or reorder the information on the Today screen

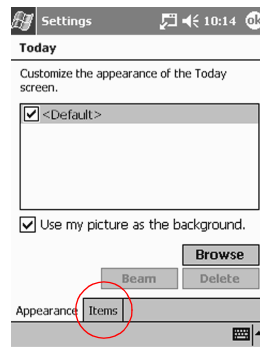

Tap to select an item

Tap Move Up or Move Down to reorder the item; you cannot move Date

Tap to select an item

Tap Options to select display options for that item; you cannot select options for Date, Owner Info, or Inbox

5 Tap Display to set a time before the Today screen is displayed

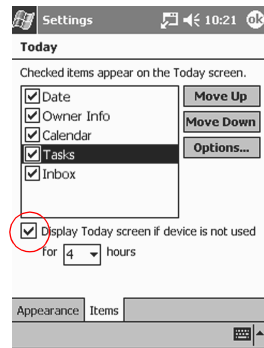

6 Tap the down arrow to select the amount of time that

passes before you see the Today screen

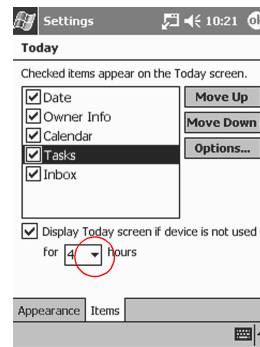

7 Tap OK
Use the Calendar

- Use the Calendar to
- schedule appointments
 - set reminders

View your calendar by

- agenda
- day
- week
- month
- year

Hint: Keep the amount of information in your appointments small to conserve memory.

Hint: Press the Calendar application button to navigate quickly to Calendar.

Look at your Calendar

By default, the Calendar first appears in the Agenda view, which provides the most detail about your appointment.

1 From the Start menu, tap Calendar

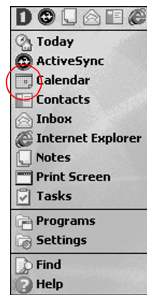

Schedule an appointment and set a reminder

Hint: Keep the amount of information in your appointments small to conserve memory.

Hint: Schedule an appointment and set a reminder from the Today screen.

- 1 From the Start menu, tap Calendar**
- 2 Tap New to schedule an appointment**

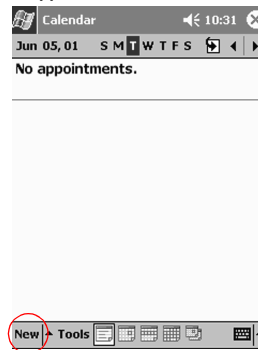

3 Enter the subject

Tap the down arrow to select a predefined subject

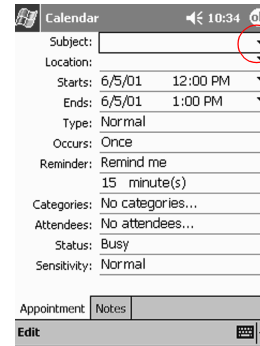

If you do not enter a subject, you see No subject in the field

4 Tap any item to enter additional information

For example, to schedule an All Day appointment, tap Type and tap All Day

By default, a reminder of 15 minutes is set

5 Tap 15 and tap the down arrow to change the time of the reminder

6 Tap minute(s) to change the unit of time

7 Tap OK to set the reminder and schedule the appointment

Delete an appointment

Hint: Tap and hold an appointment and choose Delete Appointment from the pop-up menu to delete an appointment.

1 From the Start menu, tap Calendar

2 Tap an appointment to view it

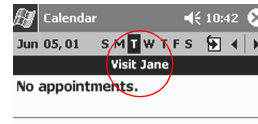

3 Tap Tools



4 Tap Delete Appointment

5 Tap Yes to delete the appointment permanently

Use Tasks

- Use Tasks to
- create new tasks
 - delete a task

Create a task and set a reminder

Hint: Create a task and set a reminder from the Today screen.

1 From the Start menu, tap Tasks

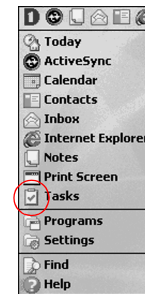

2 Tap New to create a new task

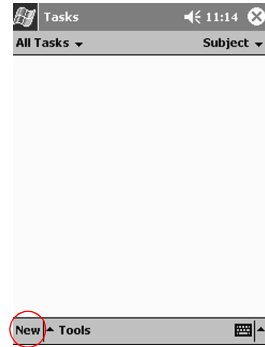

3 Enter the subject

Tap the down arrow to select a predefined subject

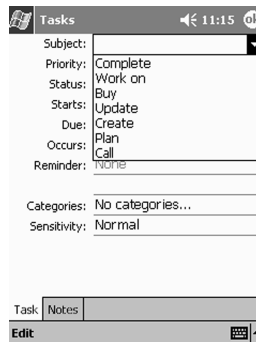

If you do not enter a subject, you see No subject in the field

4 Tap any item to enter additional information

For example, tap the Sensitivity field and tap Private to make the task private

5 Tap Due to add a due date for the task

6 Tap Reminder and select Remind me

7 Tap the date to select when you want to be reminded

8 Tap OK to set the reminder and create the task

Delete a task

Hint: Tap and hold a task and choose Delete Task from the pop-up menu to delete a task.

1 From the Start menu, tap Tasks

2 Tap the task you want to delete

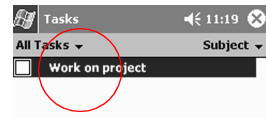

3 Tap Tools

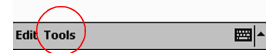

4 Tap Delete Task

5 Tap Yes to permanently delete the task

With the applications on your Compaq iPAQ Pocket PC H3700 Series, be up to date and organized even away from your computer.

Use Microsoft Reader

Please note that a detailed eBook guide is available on the CD-ROM, and you can also copy it to your Compaq iPAQ Pocket PC.

Hint: You may need to activate Microsoft Reader before you can copy protected eBooks from the Internet. You must have a Hotmail, MSN, or Passport account to activate your reader.

Activate Microsoft Reader

Activate Microsoft Reader to copy protected eBooks.

- 1 Connect your Compaq iPAQ Pocket PC to your computer
- 2 Open Internet Explorer on your computer
- 3 Go to <http://das.microsoft.com/activate>

Read an eBook

Read your eBook from start to finish or select specific topics. If you close your eBook and later want to

open it, your eBook will open on the last page you read.

- 1 From the Start menu, tap Programs
- 2 Tap Microsoft Reader
- 3 Tap the title of your eBook
- 4 Tap the page number or left and right arrows to move

Using Software

backward and forward in the book



Hint: To jump to a topic, tap a link. Links can occur throughout the text or table of contents. To return from a link, tap the title of the eBook and tap Return.

Regulatory Notices

Federal Communications Commission Notice

This equipment has been tested and found to comply with the limits for a Class B digital device, pursuant to Part 15 of the FCC Rules. These limits are designed to provide reasonable protection against harmful interference in a residential installation. This equipment generates, uses, and can radiate radio frequency energy and, if not installed and used in accordance with the instructions, may cause harmful interference to radio communications. However, there is no

guarantee that interference will not occur in a particular installation. If this equipment does cause harmful interference to radio or television reception, which can be determined by turning the equipment off and on, the user is encouraged to try to correct the interference by one or more of the following measures:

- Reorient or relocate the receiving antenna
- Increase the separation between the equipment and receiver
- Connect the equipment into an outlet on a circuit different from

that to which the receiver is connected

- Consult the dealer or an experienced radio or television technician for help

Modifications

The FCC requires the user to be notified that any changes or modifications made to this device that are not expressly approved by Compaq Computer Corporation may void the Reference authority to operate the equipment.

Cables

Connections to this device must be made with shielded cables with

metallic RFI/EMI connector hoods in order to maintain compliance with FCC Rules and Regulations.

Declaration of Conformity for products marked with the FCC logo—United States only

This device complies with Part 15 of the FCC Rules. Operation is subject to the following two conditions: (1) this device may not cause harmful interference, and (2) this device must accept any interference received, including interference that may cause undesired operation.

For questions regarding your product, contact:

Compaq Computer Corporation
P. O. Box 692000, Mail Stop

530113
Houston, Texas 77269-2000

Or, call 1-800-652-6672
(1-800-OK COMPAQ)

For questions regarding this FCC declaration, contact:

Compaq Computer Corporation
P. O. Box 692000, Mail Stop
510101
Houston, Texas 77269-2000
Or, call (281) 514-3333

To identify this product, refer to the Part, Series, or Model number found on the product.

Canadian Notice

This Class B digital apparatus meets all requirements of the Canadian Interference-Causing Equipment Regulations.

Avis Canadien

Cet appareil numérique de la classe B respecte toutes les exigences du Règlement sur le matériel brouilleur du Canada.

European Union Notice

Products bearing the CE marking comply with both the EMC Directive (89/336/EEC) and the Low Voltage Directive (73/23/EEC) issued by the Commission of the European Community and if this product has telecommunication functionality, the R&TTE Directive (1999/5/EC).

Compliance with these directives implies conformity to the following European Norms (in parentheses are the equivalent international standards and regulations):

- EN55022 (CISPR 22) - Electro-magnetic Interference
- EN55024 (IEC61000-4-2, 3, 4, 5, 6, 8, 11) - Electromagnetic Immunity
- EN61000-3-3 (IE61000-3-3) - Power Line Flicker
- EN 60950 (IEC60950) - Product Safety

Japanese Notice

この装置は、情報処理装置等電波障害自主規制協議会（VCCI）の基準に基づくクラスB情報技術装置です。この装置は、家庭環境で使用することを目的としていますが、この装置がラジオやテレビジョン受信機に近接して使用されると、受信障害を引き起こすことがあります。

取扱説明書に従って正しい取り扱いをして下さい。

Battery Warning

WARNING: This computer contains an internal lithium polymer battery pack. To reduce the risk of fire or burns, do not disassemble, crush, puncture, short external contacts, or dispose of in fire or water.

Replacement should only be done by a Compaq authorized service provider using the Compaq spare part for this computer.

Airline Travel Notice

Use of electronic equipment aboard commercial aircraft is at the discretion of the airline.

Power Cords

If you were not provided with a power cord for your Compaq iPAQ

Pocket PC H3700 Series or for an AC power accessory intended for use with your device, you should purchase a power cord that is approved for use in your country.

The power cord must be rated for the product and for the voltage and current marked on the product's electrical ratings label. The voltage and current rating of the cord should be greater than the voltage and current rating marked on the product. In addition, the diameter of the wire must be a minimum of 0.75 mm \approx 18AWG, and the length of the cord must be between 5 feet (1.5 m) and 6.5 feet (2 m). If you have questions about the type of power cord to use, contact your Compaq authorized service provider.

A power cord should be routed so that it is not likely to be walked on or pinched by items placed upon it or against it. Particular attention should be paid to the plug, electrical outlet, and the point where the cord exits from the product.

WARNING: To reduce the risk of personal injury, electric shock, fire, or damage to the equipment:
Do not disable the power cord grounding plug. The grounding plug is an important safety feature.

Plug the equipment into a grounded (earthed) electrical outlet that is easily accessible at all times.
Disconnect power from the equipment by unplugging the power cord from the electrical

outlet.
Do not place anything on power cords or cables. Arrange them so that no one may accidentally step on or trip over them.
Do not pull on a cord or cable. When unplugging from the electrical outlet, grasp the cord by the plug.

WARNING: To reduce the risk of electrical shock, fire, or damage to the equipment:
Do not use converter kits sold for appliances to power the computer.

Hardware Specifications

System Specifications

Feature	Compaq iPAQ H3700 Series
Processor	StrongARM SA-1110
Memory	32 MB SDRAM or greater
Display	Color TFT, 240 x 320 pixels, 4K-color support, .24-dot pitch
Backlight	5-level brightness adjustment, light sensor for automatic adjustment of brightness level
Audio	Speaker, 3.5 mm stereo headphone jack
Infrared	IrDA, data transfer up to 115.2 Kb per second

System Specifications

Feature	Compaq iPAQ H3700 Series
Communications	Communication port, Expansion Pack connector
Indicators	3 mode alarm notification: flashing green LED, tone, pop-up message. Charge light: flashing/solid amber LED
Battery	Lithium Polymer

Physical Specifications

	Compaq iPAQ Pocket PC H3700	
	US	Metric
Height	5.1 in	130 mm
Width	3.3 in	84 mm
Depth	.63 in	16 mm
Weight	6.4 oz	181 g

Operating Environment

		US	Metric
Temperature	Operating	32° to 104°F	0° to 40°C
	Nonoperating	-4° to 140°F	-29° to 60°C
Relative Humidity	Operating	29 to 90%	29 to 90%
	Nonoperating	29 to 90%	29 to 90%
Maximum altitude	Operating	15,000 ft	4,572 m
	Nonoperating	40,000 ft	12,192 m

Operating Environment

Routine Care

To keep your Compaq iPAQ Pocket PC H3700 Series in good condition and working properly, follow these guidelines:

- Keep your Compaq iPAQ Pocket PC away from excessive moisture and temperature extremes. Do not expose your Compaq iPAQ Pocket PC to liquids or precipitation.
 - Do not place anything on top of your Compaq iPAQ Pocket PC to prevent damage to the screen.
- Store your Compaq iPAQ Pocket PC in a protective case when not in use.
 - Clean your Compaq iPAQ Pocket PC by wiping the screen and the exterior with a soft, damp cloth moistened only with water.
 - Avoid exposing your Compaq iPAQ Pocket PC to direct sunlight or strong ultraviolet light for extended periods of time. Also avoid scratching the surface of the screen and banging it against hard objects.

- Only use the Compaq iPAQ Pocket PC stylus to prevent scratching the screen.

Battery Guidelines



Because of the type of battery used in your Compaq iPAQ Pocket PC, follow local regulations regarding the safe disposal of your Compaq iPAQ Pocket PC. Your Compaq vendor can advise you on local regulations, and/or the existence of any battery disposal programs in operation.



The Compaq iPAQ Pocket PC should not be disposed of along with the general household waste. In order to forward them to recycling or dispose of them properly, please use the public collection system or return them to Compaq, your authorized Compaq partners, or their agents.



In North America, dispose of the Compaq iPAQ Pocket PC by taking advantage of the Compaq battery recycling program. You will be provided with a postage-paid battery pack mailer pre-addressed to a reclamation facility where the metals are recycled.

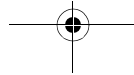

spray liquid directly on the screen or allow excess liquid to drip inside your Compaq iPAQ Pocket PC. Using soap or other cleaning products on the screen may discolor the finish and damage the screen.

